

Aluminium extension arm WR-3/2

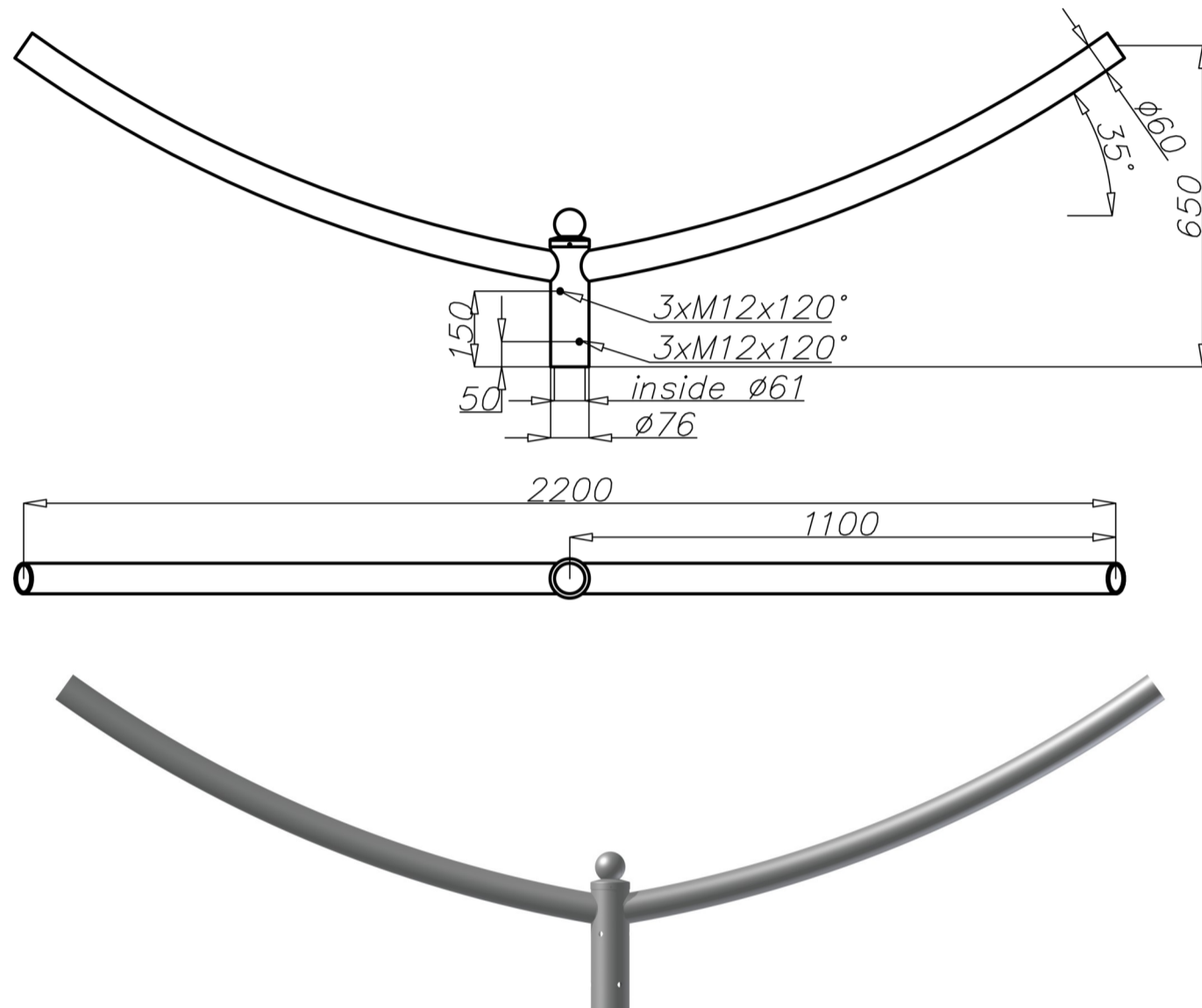

Technical data

Extension arm	WR-3/2
Product code	472032
Application	aluminium columns with ending $\varnothing 60 \times 180$
Arm quantity	2
Net weight [kg]	4,9
Windage [m ²]	0,159
Volume [m ³]	0,07
Assembling diameter of luminaire [mm]	$\varnothing 60 \times 100$
Compatible luminaires	street luminaires

- anodising in 10 colours, each with possibility of brightening
- option of powder painting in RAL colours (other colours available on request)
- packing: sleeve material
- CE certificate valid for use on poles manufactured by ROSA company